

Xladeco

Internal doors and
partitions system



EXLABESA

ARCHITECTURE

Exlabesa Building Systems Ltd.

Ogden Road - Wheatley Hills
DONCASTER DN2 4SG
Tel. +44 01302 762500 Fax + 44 01302 762557
www.exlabesa.co.uk



Exlabesa Building Systems Ltd. prohibits the total or partial reproduction of this catalogue by any written means, as well as magnetic or electronic support, without our express written authorisation.
Exlabesa Building Systems Ltd. reserves the right to modify, improve or delete any of the products shown in this catalogue without prior notice.
Exlabesa Building Systems Ltd. accepts no responsibility for any possible misprints that may appear in this catalogue and recommends that, before placing any order, the customer verifies that the references that appear here are correct. Exploded views, bills of materials, modulations and discounts included in all models are for guidance only and it is the responsibility of the customer to check before proceeding with an order.



Eye-catching industrial-style solution extremely easy to fabricate

Xladeco offers a versatile and elegant design solution for internal doors and partitions. Its slim sightlines and sleek style delivers a contemporary industrial aesthetic for any residential or commercial project.

Whether you're looking to create a Georgian-style internal door, a striking internal room divider, or an eye-catching industrial-style statement, the Xladeco system offers unparalleled flexibility. Choose from a variety of configurations, including fixed screens, single doors, French doors, or even corner setups, all designed to maximise natural light and transform spaces with modern sophistication.

Perfectly aligned with the latest interior design trends, the Xladeco system is an ideal choice for those who value style and functionality.

Beyond its visual appeal, the Xladeco system is engineered for efficiency. Its innovative Quickfit assembly system ensures a smooth fabrication process, free of complex machining or punching operations, cutting down fabrication times and reducing costs without compromising quality.



Key benefits

Modern yet timeless design

Featuring a sleek industrial aesthetic that complements both contemporary and classic interiors.

Effortless fabrication

Engineered for a quick and easy assembly, eliminating complex machining or punching operations.

Ultra-slim aluminium profiles

Designed to maximise natural light, creating open spaces with minimal visual obstruction.

Versatile door options

Choose from hinged, sliding, or pivoting door configurations to suit any interior layout and functionality needs.

Customisable finishes

Available in large range of colours and finishes, allowing you to tailor the system to match any design preference.



Classic Georgian style

The industrial aesthetic, which emphasises authentic materials and exposed structures, has become one of the most popular interior design trends. The Xladeco system, with its ultra-slim profiles and heritage look, offers a sophisticated way to divide spaces, without compromising luminosity or a feeling of spaciousness.

Inspired by the classic steel doors, these Georgian style statement products combine lightness and functionality for a perfect fusion with minimalist styles, to create modern, welcoming environments in any type of residential or commercial project.

Timeless elegance

The Xladeco internal door system brings together functionality and elegance, to create open spaces that can enhance the personality and originality of any environment. Extruded using premium grade aluminium, Xladeco profiles are lightweight yet strong, offering durable, low-maintenance solutions with endless customization possibilities. These internal doors provide effortless operation with bespoke configurations and a sophisticated touch to any setting.



Open,
modular
spaces



Xladeco internal doors and partitions not only enhance the style and flexibility of any space but also enable the seamless creation of multi-functional areas, allowing diverse activities and uses to coexist harmoniously within the same environment.



Unlimited design options with glass, opaque wooden panels or other materials.

Choose from either a fixed screen, door configuration or combination, Xladeco provide a flexible system that lets you create bespoke eye-catching solutions based on your specific needs and requirements.







Maximum Luminosity

Luminosity plays a starring role in any welcoming environment. Xlodeco provides a sleek, classic aesthetic for your living area or commercial space, allowing light to flood unhindered through the building, creating a sense of airiness and spaciousness.

Openings

This system offers three types of doors, which can be combined with fixed side and upper screens. The hinged, pivoting, and sliding door options available with the *Xladeco* system provide practical solutions for any type of space or need, for efficient functionality and maximum versatility. In addition, the system features built-in handles that ensure a smooth, flawless and effortless operation.

FIXED SCREEN

Straight or angled fixed panels

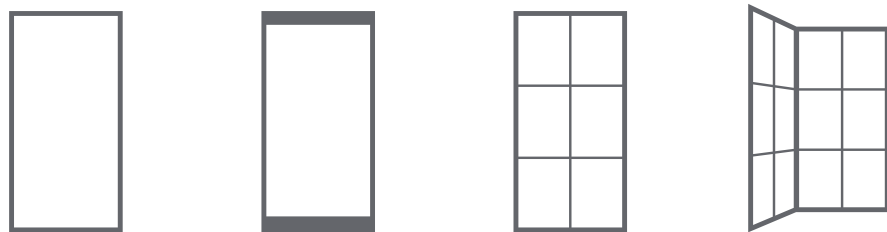

HINGED DOORS

Single sash / Double sash

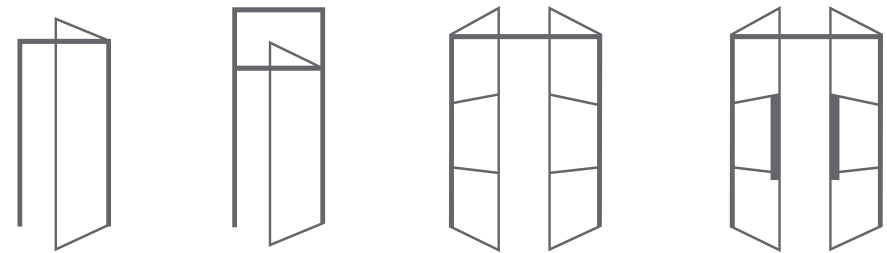

PIVOTING DOOR

Single sash / Double sash

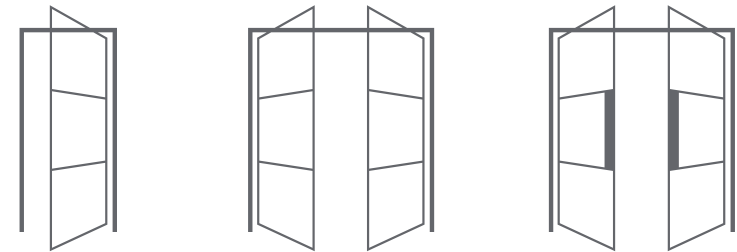

SLIDING DOOR

Single sash / Double sash

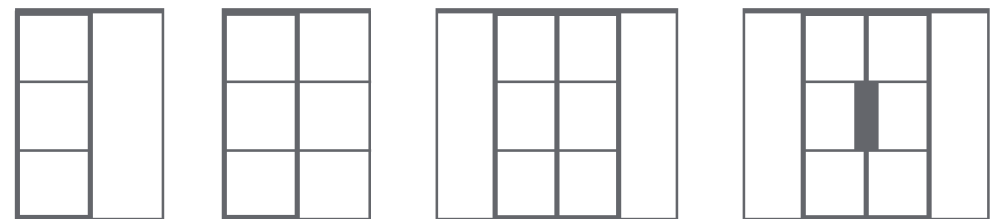

Configurations

Xladeco is a fully modular system for creating internal room dividers with glass and solid panels, with slim sightlines and sleek style. From glass partition walls to Georgian-style internal door or corner configurations, the Xladeco profiles offer maximum versatility and can be adapted to any project or space.

Options with glass or solid panels

The system's flexibility allows for virtually limitless design possibilities. Alongside options with glass panels —such as monolithic or laminated glass in various thicknesses— the frames can also accommodate solid panels crafted from wood or other materials. These options let you create open, well-lit spaces, as well as design solutions for internal doors and partitions that will maintain privacy in specific areas.

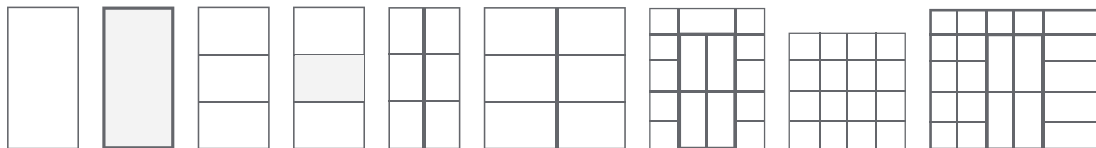

Transoms and mullions profiles



Structural options

Ideal for large doors and fixed screens

Solid, robust structure

40 mm transoms and mullions

Georgian bar option

Ultra-slim sightlines and sleek style profiles, for doors of up to 1 metre wide

Easy to install

25 mm vertical and horizontal profiles

Door locks

The system offers various types of door locks, for easy adaptation to specific needs and configurations. These range from practical, elegant, and minimalist magnetic locks, to strong latching mechanisms with lever handles. All these possibilities will ensure ease of use in any space, while still presenting sleek, classic Georgian style statement.



Magnetic lock

With the magnetic elements concealed in the profiles, this option provides a simple, practical design and minimalist aesthetic.

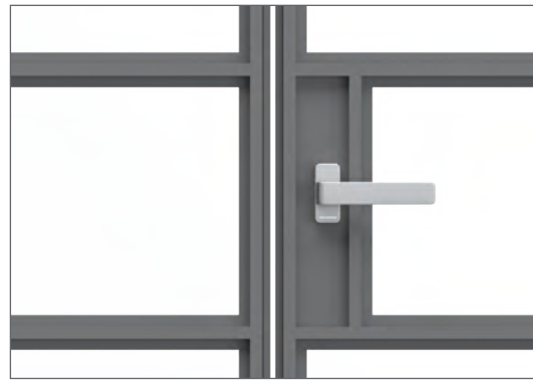

Magnetic lock for deadbolt or key

There are also options featuring a latching mechanism with lever handles, for enhanced solidity and privacy.

Pull and lever handles

Xlodeco provides options with built-in pull handles, adapted to the different types of doors, including single and double pull handles for hinged and pivoting doors, as well as a special built-in handle for sliding doors. It is also possible to use Exlabesa's exclusive Iconic handle levers.

Double built-in pull handle



Simple built-in pull handle

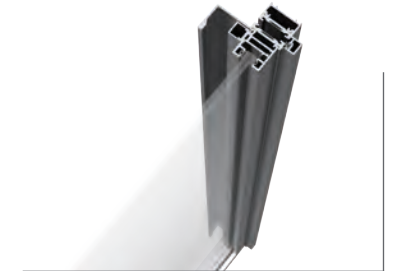



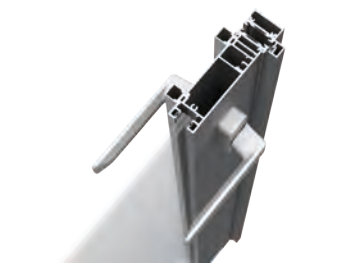

Lever handle option



Built-in pull handle for sliding doors



Technical specifications

Tipology				
Maximum weight	100 kg	100 kg	200 kg	140 kg
Maximum width	3150 mm	1200 mm	2500 mm	1400 mm
Maximum height	3150 mm	2500 mm	2500 mm	2500 mm

Glass

Laminated glass
5+5 / 4+4 / 3+3

Monolithic glass
12 / 10 / 8 / 6

Cross-sections

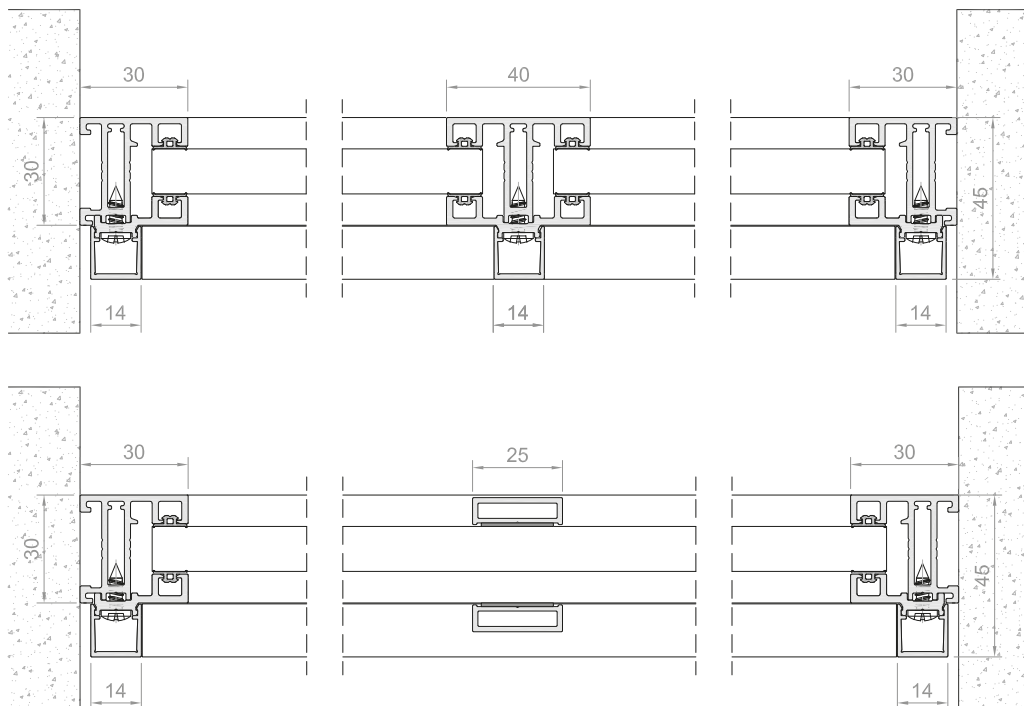

Finishes

Extruded using premium grade aluminium, **Xladeco** offers maximum creative freedom and options for customisation. The Xladeco profiles are available in any colour from the RAL chart, and also in anodised finishes. All of these provide an almost limitless range of surface finishing options, allowing you to choose a style that perfectly complements any decorative or design environment.

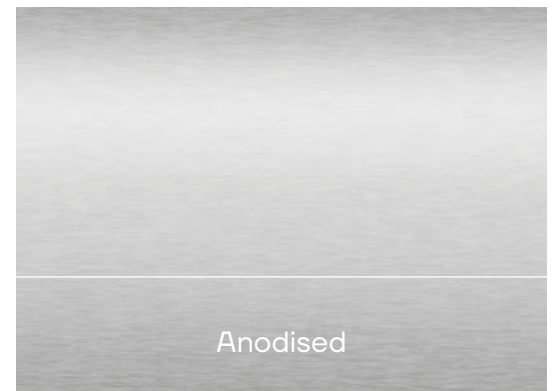
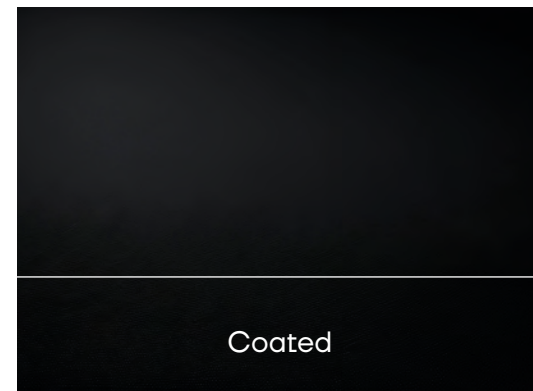

Guarantee of quality and durability

Our finishes deliver long-lasting quality. Our painting plant is certified under the Qualicoat label, ensuring the highest quality in our production procedures, processes, and the final product.

List of profiles

EXL-14304	30 mm frame and sash door	EXL-14305	40 mm mullion and transom	EXL-14424	Union coupler	EXL-14312	Rebate adaptor	EXL-14313	Double handled sash trim	EXL-14425	Handled sash trim
EXL-14306	26 mm pressure plate	EXL-14307	40 mm pressure plate	EXL-14426	26 mm plate with handle	EXL-14420	26 mm door sash with handle	EXL-14421	Sash lock coupler	EXL-14448	Door deep rail
EXL-14310	Cover cap	EXL-14311	Sash trim	EXL-14521	Sliding guide	EXL-14422	25 mm georgian bar	EXL-14423	Sash trim coupler	EXL-14522	Sliding guide cover cap

Assembly

Quick and easy to assemble, to optimise fabrication times and reduce costs

The Xladeco internal doors and partitions stand out for their innovative Quickfit assembly system, designed to streamline the fabrication process. L and T connectors enable effortless assembly of transoms and mullions, ensuring quick and efficient frame construction. This mechanical solution offers quick and easy assembly, free of special tools (CNC, punching tools etc) and complex machining operations. In addition, the trim profile is fixed by clipping the profile, creating a perfect finish for a eye-catching industrial-style statement and traditional heritage look. This simple assembly process optimises fabrication time and costs, while ensuring perfect results for every project.

Mechanical assembly achieved with L and T connectors

No need for special tools or CNC. No need for complex machining operations

Trim profile fixed by clip

Frame assembly

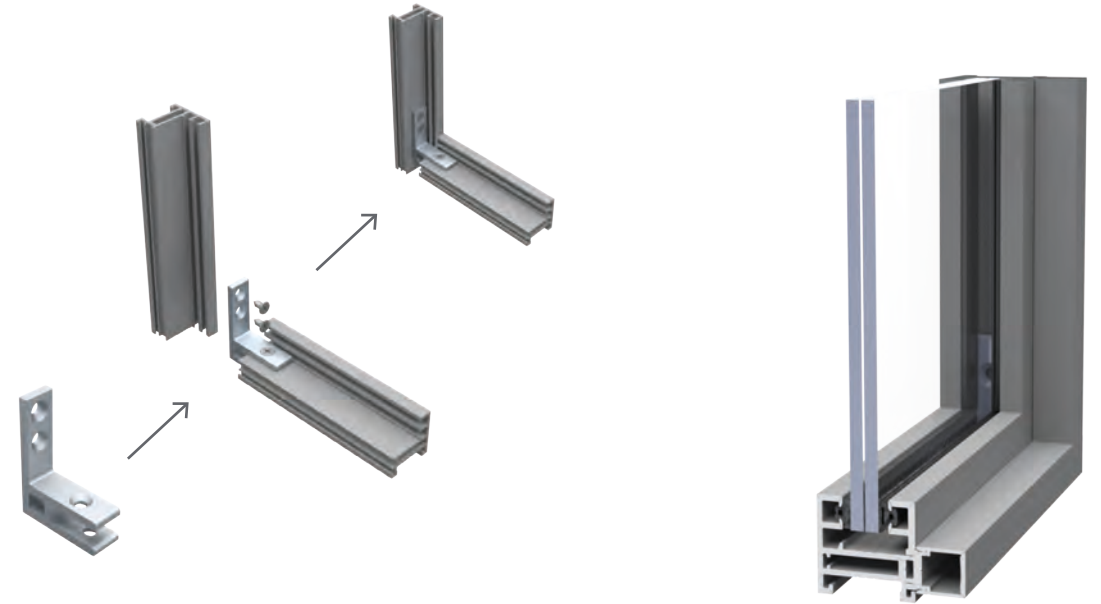

40 mm transoms and mullions assembly

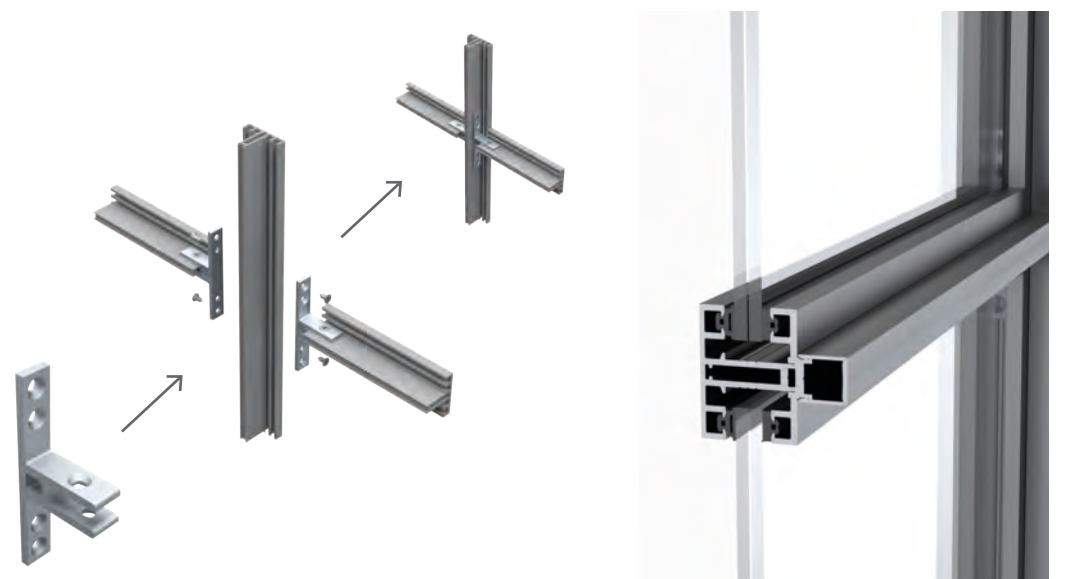





Exlabesa Building Systems Ltd.

Ogden Road - Wheatley Hills
DONCASTER DN2 4SG
Tel. +44 01302 762500 Fax +44 01302 762557
www.exlabesa.co.uk

QUALICOAT | ISO 9001